

Smart High-Performance Positioner (SHP)
Quick start guide 4059



For more information, scan the QR code to access the complete product manual on our website.



Version Control	Date of Issue	Issued by	Approved by
Rev. 00	05 November 2024	T. Stupka	R. Valoti

PNEUMATIC CONNECTION

There are two main pneumatic configurations depending on the type of actuator:

SINGLE ACTING CONNECTION

In this configuration, the air supply is connected to port S of the positioner. The port B is not used. The port A is connected to the chamber A of the actuator.

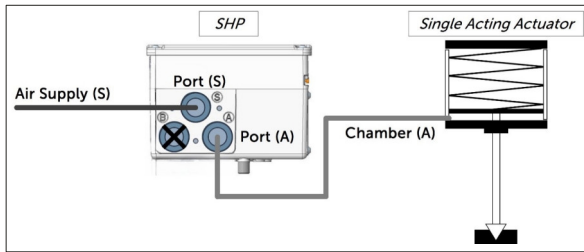

Fig. 1 Typical Single Acting Connection

DOUBLE ACTING CONNECTION

In this configuration, the air supply is connected to the port S of the positioner. Ports A and B are connected to chambers A and B of the actuator, respectively.

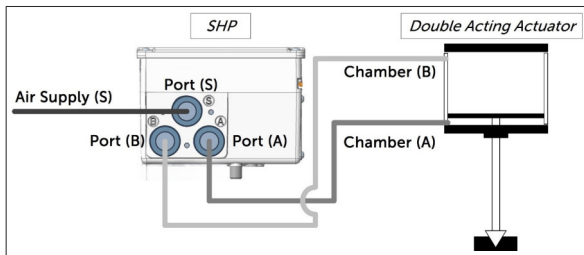
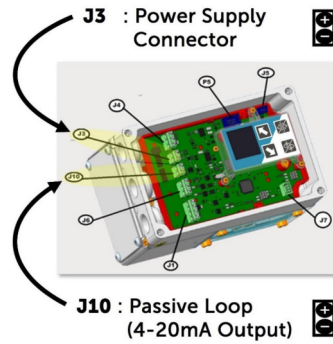

Fig. 2 Typical Double Acting Connection

WARNING
Air Supply Quality:
The air supply quality must comply with **ISO 8573-1:2010 class [3:3:3]**.

Failure Position and Tubing Connections:
The failure position and tubing connections depend on the application!

ELECTRICAL CONNECTION



1. Connect the **4-20mA power supply** to the positioner's **J3 connector**, ensuring the correct polarity. You can use a multimeter as a power supply for the initial test. Ensure the **input voltage does not exceed 30V**.
2. Power the SHP positioner. If everything is functioning correctly, the local user interface should activate **within 2 seconds**. If not, review the wiring and the connection polarity.
3. Optionally, connect a second multimeter to the **J10 connector** to monitor the **Passive Loop (4-20mA Output)**.

WARNING
The setpoint is a **4-20mA signal not a fixed voltage!**
For detailed information, please check the full product manual on our website.

LOCAL USER INTERFACE AND CONTROLS
DISPLAY

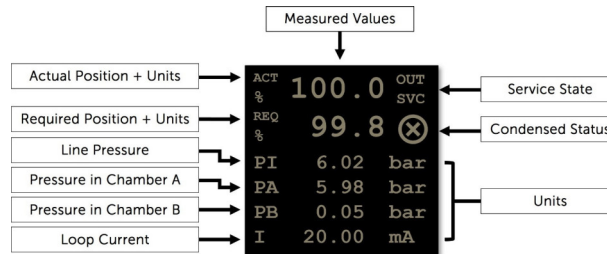

CONTROL BUTTONS

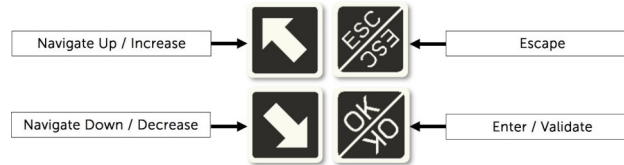

QUICK SETUP PROCEDURE

It is possible to setup the SHP positioner using the **Local User Interface**. Please follow the following steps to complete the initial configuration.

1. Press **OK** and type the following **5-digit pin code** sequence to access the menus:



WARNING
Do not type the pin too fast otherwise the key might not be detected!

2. Using the **'UP'** and **'DOWN'** keys navigate to **CALIBRATION** and press **'OK'**, then select **FULL** and press **'OK'** again to initiate the system calibration. A wizard will guide you through the setup process for the positioner.

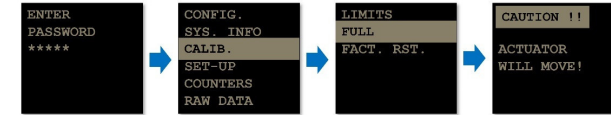

3. If the orientation of the Local User Interface needs to be adjusted, navigate to the following menu.



4. Ensure the positioner is responding correctly to input commands by **varying the 4-20mA input signal**.

ADVANCED SETUP OPTIONS

For advanced configurations you can use **High-speed data transfer USB cable** or a certified **HART Modem** to connect the positioner to a **PC**. You can download the official **Remote Control software** on our website (see QR code). The **High-speed data transfer USB cable** is available upon request. Please contact our sales team to place an order.

ALTERNATIVE CONNECTIVITY

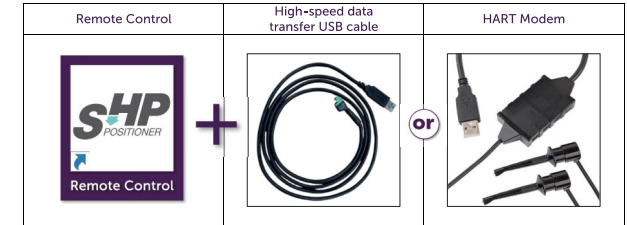

MENU MAP

The Local User Interface is organized into six main menus:

Main Menu	
1	Configuration
2	System Info
3	Calibration
4	Set-up
5	Counters
6	Raw Data

The detailed map of each main menu is provided on the other side of the paper.

